

SAW Bandpass Filter 251652B



1. Features

- IF bandpass filter
- High attenuation
- Single-ended operation
- SMD Package
- Maximum Storage Temperature Range : -40 °C ~ 85 °C
- Electrostatics Sensitive Device (ESD)

2. Package Dimension

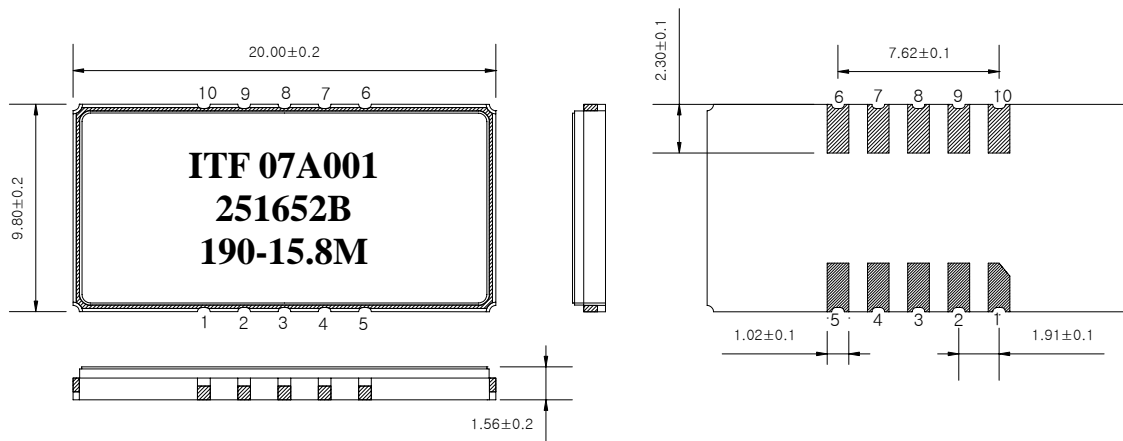

Package : S2098

Dimensions shown are nominal in millimeters

Base : Fe(SPCC), Au plating over Ni plated

Cap : Cu & Cr Alloy, Ni Plated

Termination : Kovar, Au Plated

Pin Configuration	
10	Input
5	Output
1, 4	Ground
2,3,6,7,8,9	Case ground



ITF Co., Ltd.
 102-901, Bucheon Technopark 364,
 Samjeong-Dong, Ojeong-Gu, Bucheon-City,
 Gyeonggi-Do, Korea 421-809

Part No.	251652B	
Rev. Date	2007-04-11	
Rev.	NM7010-CS01	1/5

SAW Bandpass Filter 251652B



3. Specifications

Fo = 190.0 MHz

Terminating source impedance : 50Ω and matching network

Terminating load impedance : 50Ω and matching network

		Minimum	Typical	Maximum
Center Frequency	MHz	-	190.0	-
Insertion Loss	dB	-	26.0	27.5
1dB Bandwidth	MHz	-	15.75	-
3dB Bandwidth	MHz	16.0	16.15	-
40dB Bandwidth	MHz	-	17.8	18.0
Amplitude Ripple (Fo +/- 7.5 MHz)	dB	-	0.7	1.0
Group Delay Variation (Fo +/- 7.5 MHz)	nsec	-	40	100
Absolute Delay	usec	-	2.93	-
Ultimate Rejection	dB	50	55	-
Temperature Coefficient of Frequency	ppm/°C	-	-18	-

Notes :

- 1) All specifications are based on the matching schematic shown below
- 2) All specifications are measured by Agilent Network analyzer and full 2 port calibration at room temperature
- 3) All attenuation measurements are measured relative to insertion loss

 Integrated Technology Future	ITF Co., Ltd. 102-901, Bucheon Technopark 364, Samjeong-Dong, Ojeong-Gu, Bucheon-City, Gyeonggi-Do, Korea 421-809	Part No.	251652B	
		Rev. Date	2007-04-11	
		Rev.	NM7010-CS01	2/5

SAW Bandpass Filter 251652B



4. Matching Schematic

(Actual matching values may vary due to PCB layout and parasitics)

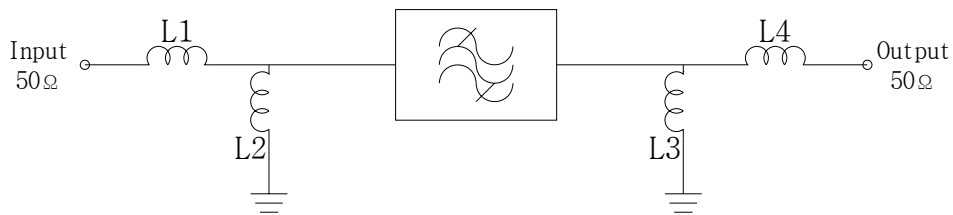

L1 = 27nH, L2 = 27nH, L3 = 27nH, L4 = 27nH

5. Marking Configuration

ITF¹⁾ 07A001²⁾

251652B³⁾

190⁴⁾ -15.8M⁵⁾

- 1) Manufacturer name
- 2) Lot Number
- 3) Part Number
- 4) Center Frequency
- 5) 1dB-Bandwidth

 Integrated Technology Future	ITF Co., Ltd. 102-901, Bucheon Technopark 364, Samjeong-Dong, Ojeong-Gu, Bucheon-City, Gyeonggi-Do, Korea 421-809	Part No.	251652B	
		Rev. Date	2007-04-11	
		Rev.	NM7010-CS01	3/5

SAW Bandpass Filter 251652B



6. Typical Performance (at +25°C)

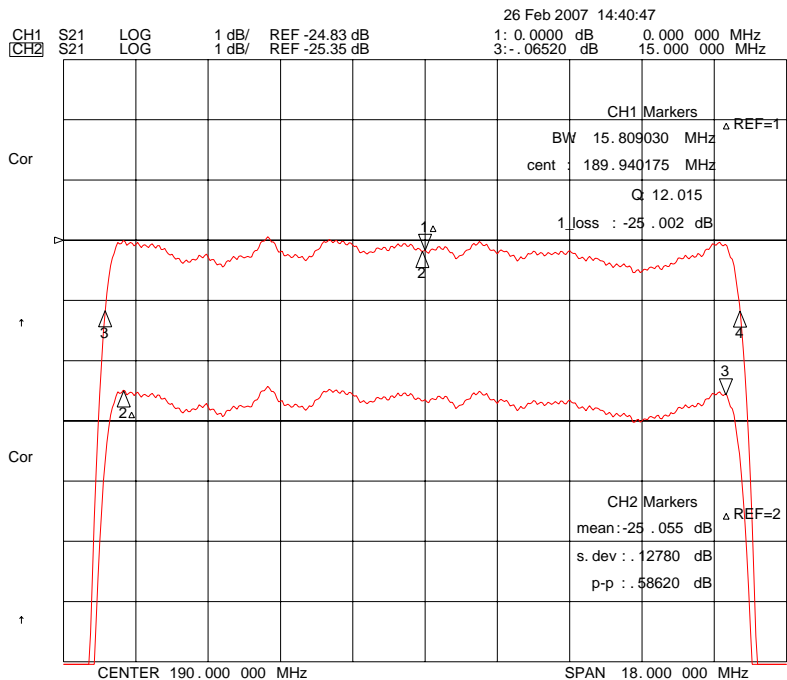
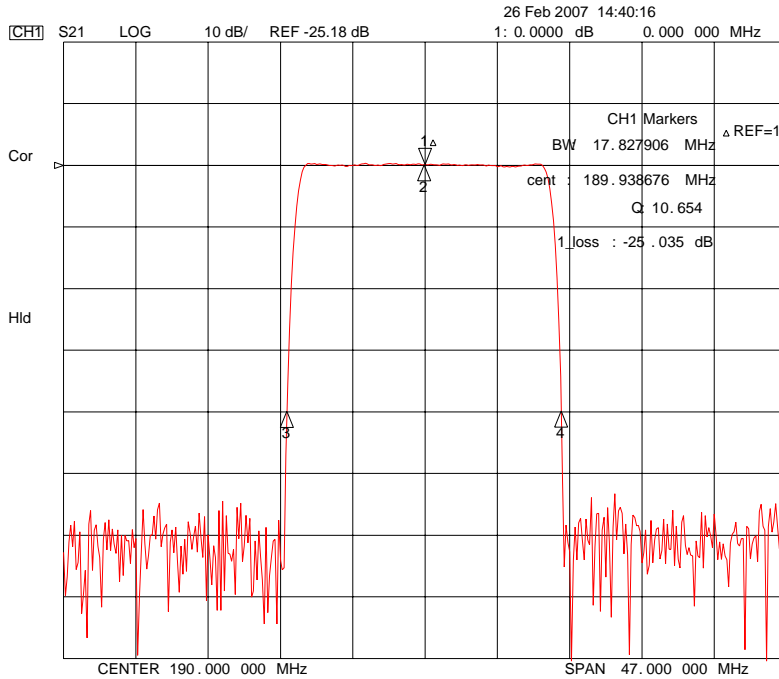

ITF Co., Ltd.
 102-901, Bucheon Technopark 364,
 Samjeong-Dong, Ojeong-Gu, Bucheon-City,
 Gyeonggi-Do, Korea 421-809

Part No. 251652B

Rev. Date 2007-04-11

Rev. NM7010-CS01 4/5

SAW Bandpass Filter 251652B

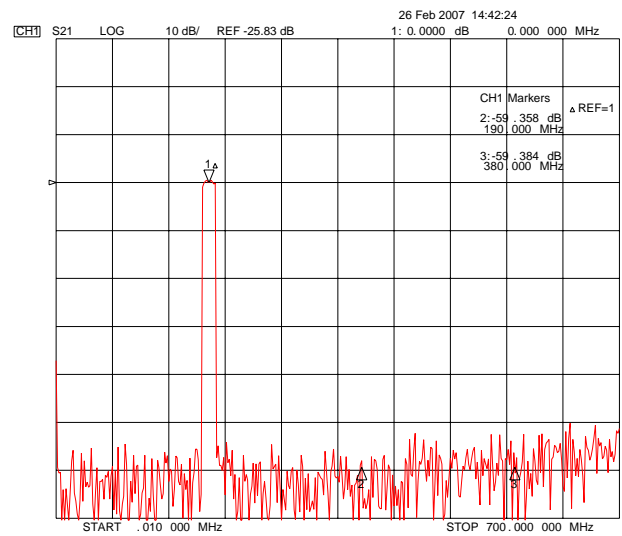
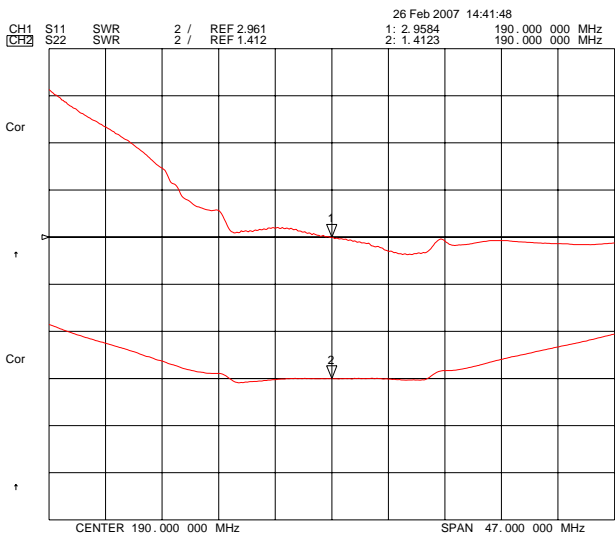
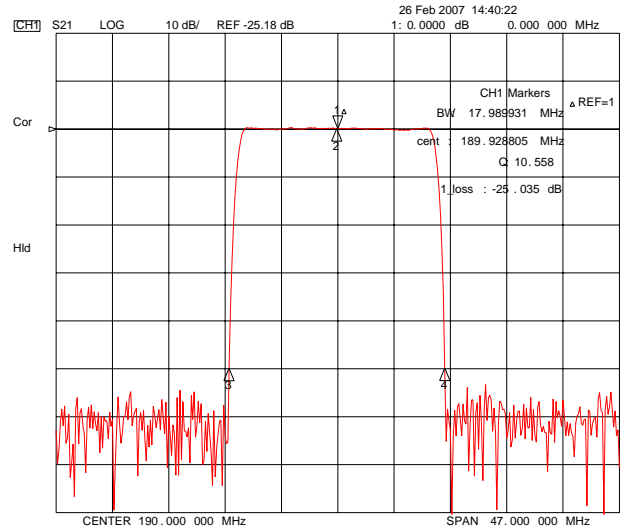
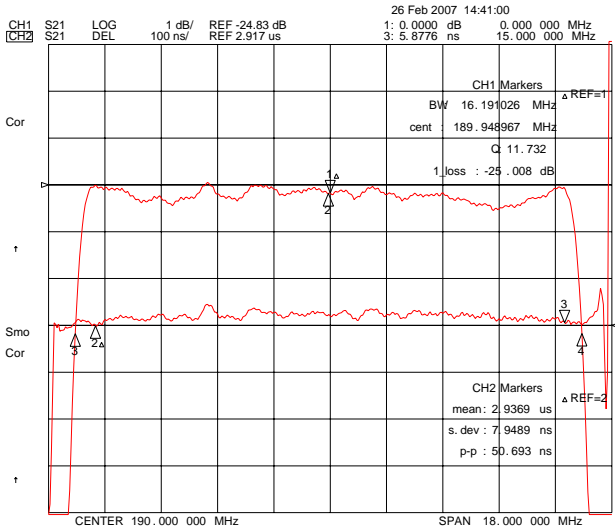

ITF Co., Ltd.
 102-901, Bucheon Technopark 364,
 Samjeong-Dong, Ojeong-Gu, Bucheon-City,
 Gyeonggi-Do, Korea 421-809

Part No.	251652B	
Rev. Date	2007-04-11	
Rev.	NM7010-CS01	5/5